

Ausgemessen und beraten von	Kunden-Kommission	Kundenanschrift / Firmenstempel

Basispreis		Aufpreis			
Art. Nr.	Profilfarbe	Glas	Glasveredelung (optional)	Griff/ Handtuchhalter	Wandbefestigung (nur rahmenlos)

<input type="checkbox"/> Montage auf Fliesenboden (Maße bis Glasaußenkante).	Produkthöhe in mm.....
<input type="checkbox"/> Montage auf Duschwanne (Wanneneinbaumaß)	Höhe Wandfliesen in mm .....

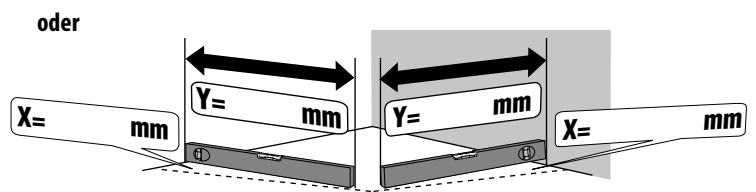
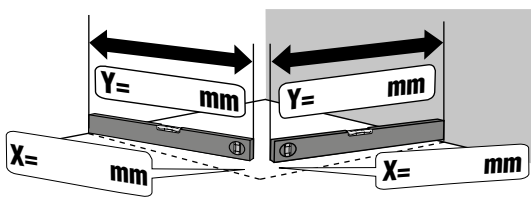
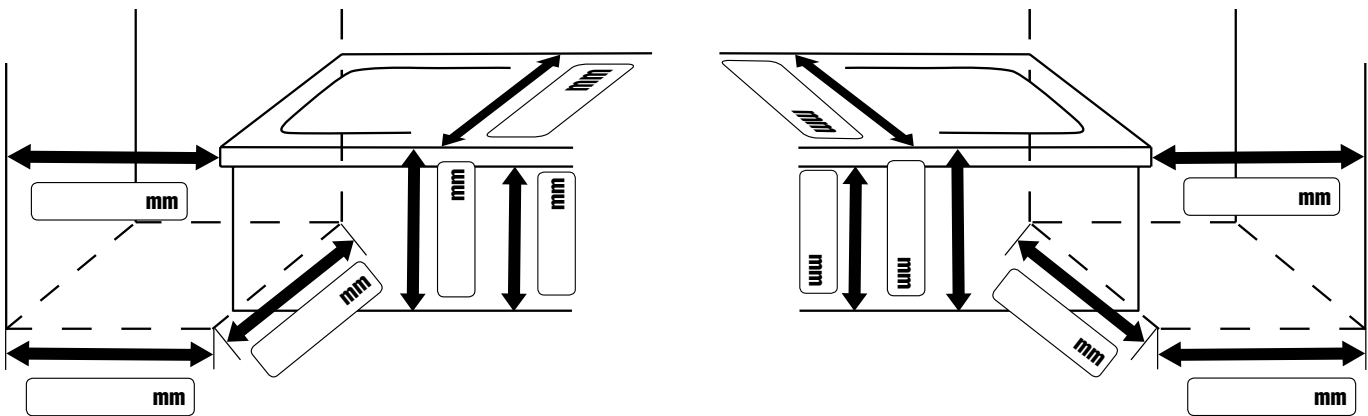

Y = Länge der Messlatte

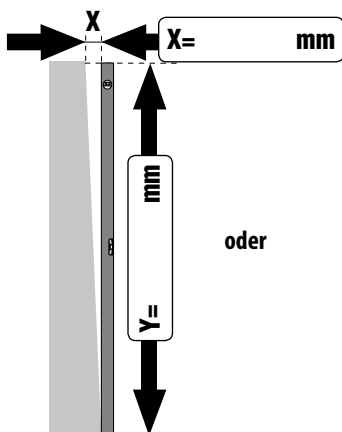

oder

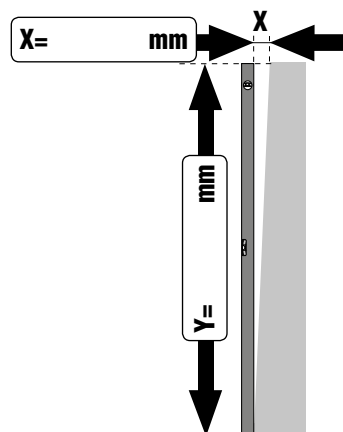
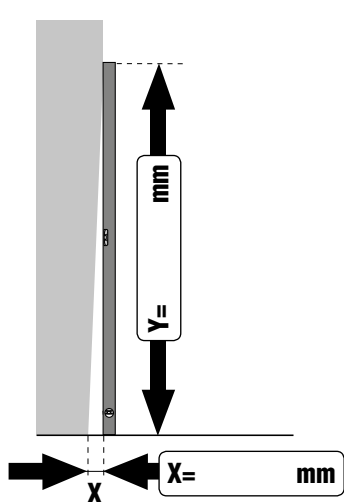

oder

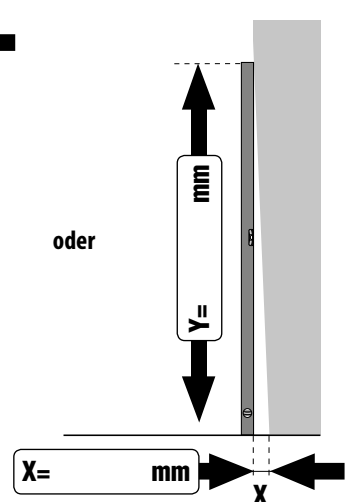

Serie:	Type:	Glas:
<input type="checkbox"/> ARTWEGER 360 <input type="checkbox"/> Twistline <input type="checkbox"/> Lifeline <input type="checkbox"/> Baseline	<input type="checkbox"/> Tür mit schwenkbarer Seitenwand	<input type="checkbox"/> EK (echtglas) <input type="checkbox"/> SA (Satin) <input type="checkbox"/> RS (Querstreifen Satin 1 lt. Skizze) <input type="checkbox"/> RW (Querstreifen Satin 2 lt. Skizze) <input type="checkbox"/> ARTCLEAR-Glas

Türmontage an :	Anzahl Türen:	Türanschlag:	Türsystem:
<input type="checkbox"/> Wand <input type="checkbox"/> Fixteil	<input type="checkbox"/> eine	<input type="checkbox"/> links <input type="checkbox"/> rechts	<input type="checkbox"/> Flügel <input type="checkbox"/> Pendel <input type="checkbox"/> Schiebe <input type="checkbox"/> Falt

Fixteile:	Farbe:	Griff:
<input type="checkbox"/> eins <input type="checkbox"/> zwei <input type="checkbox"/> keines	Profil:..... Zierteil:.....	Griffart:.....

Wandanschluss:		
Rahmenlos Wandwinkel <input type="checkbox"/> innen <input type="checkbox"/> außen  	<input type="checkbox"/> Teilgerahmt	<input type="checkbox"/> Gerahmt (Schiebetür)

Notizen:	<input type="checkbox"/> Querstreifen Satin
	